

# MILL 4277D-14 FOR ARENA 82X0

PROJECT PROJÉT
SPEC TYPE
NOTES

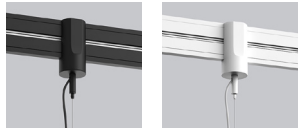

## ADAPTER FINISH FINI DE L'ADAPTATEUR



BLKE WHE

## SHADE FINISH FINI ABAT-JOUR



ADDITIONAL PREMIUM COLORS AVAILABLE - SEE ACOUSTIC MATERIAL COLOR OPTIONS PAGE

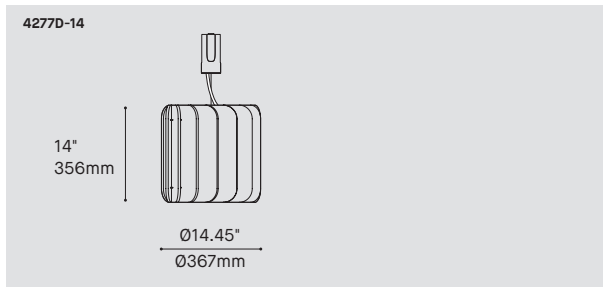

ORDERING SPECIFICATION	SPÉCIFICATION DE COMMANDE	CODE
<b>MODEL</b> MODÈLE	4277D-14 MILL DIRECT 14"	4277D-14
<b>LIGHT SOURCE</b> SOURCE LUMINEUSE	LEDA*	
<b>LEDA*</b>	SPECIAL OUTPUT FOR ARENA, 8W * TOTAL DC LOAD OF INSTALLED LIGHT SOURCES MUST NOT EXCEED 90W OR 180W DEPENDING ON THE SELECTED OPTION	
<b>COLOR TEMPERATURE</b> TEMPÉRATURE DE COULEUR	27* 2700K 30 3000K 35 3500K 40 4000K  *LONGER LEAD TIME MAY APPLY, PLEASE CONTACT YOUR EUREKA REPRESENTATIVE	
<b>COLOR RENDERING INDEX</b> INDICE DE RENDU DE COULEUR (IRC)	80 80+ CRI 90* 90+ CRI  *LONGER LEAD TIME MAY APPLY, PLEASE CONTACT YOUR EUREKA REPRESENTATIVE	
<b>CABLE</b> CÂBLE	AC AIRCRAFT MOUNTING & POWER CORD, FIELD ADJUSTABLE	AC
<b>CABLE LENGTH</b> LONGUEUR DE CÂBLE	24 24" CABLE (STD LENGTH) ** CUSTOM CABLE LENGTH (PLEASE SPECIFY)	
<b>MOUNTING</b> MONTAGE	TAA ARENA ADAPTOR FOR ARENA SQUARE & RECTANGLE 8220 & ARENA STRAIGHT 8210 TAB ARENA ADAPTOR FOR ARENA RING 8200	
<b>ADAPTER FINISH</b> FINI ADAPTATEUR	BLKE BLACK FINE TEXTURED WHE WHITE FINE TEXTURED	
<b>POWER CORD FINISH</b> FINI ADAPTATEUR	BLK BLACK POWER CORD WH WHITE POWER CORD	
<b>SHADE FINISH</b> FINI ABAT-JOUR	ABF AZURE BLUE FELT    BYF BANANA YELLOW FELT    REF RED FELT AWF ARCTIC WHITE FELT    CHF CHARCOAL FELT    SGF SILVER GRAY FELT BBF BASIC BLACK FELT    NBF NAVY BLUE FELT    TGF TITANIUM GRAY FELT BOF BLOOD ORANGE FELT    OBF OCEAN BLUE FELT    ZFF ZINFANDEL FELT BTF BATTLESHIP GRAY FELT    PGF PEAR GREEN FELT <b>PREMIUM*</b> PLEASE SPECIFY PREMIUM COLOR CODE - SEE ACOUSTIC MATERIAL COLOR OPTIONS PAGE  *LONGER LEAD TIME MAY APPLY, PLEASE CONTACT YOUR EUREKA REPRESENTATIVE	
<b>DIFFUSER FINISH</b> FINI DIFFUSEUR	WH WHITE	WH

## PRODUCT CHARACTERISTICS CARACTÉRISTIQUES DU PRODUIT



**DESIGN:** With its fifteen acoustic panels shade, Mill offers an original soft aesthetic and atmosphere enhancing functionality. Mill will help with volume control while adding a stunning design element to the decor. The custom CNC cut rigid felt acoustic panels are available in 30 colors. Composed of at least 40% of recycled polyethylene bottles (PET) which make them recyclable and odorless.

**INSTALLATION:** Magnetically positioned anywhere on the ARENA for easy on-site installation or reconfiguration of the lighting environment. The adapter has a hook for extra safety. This pendant offers evenly diffused lighting with a COB light source.

**LIGHT SOURCE:** Custom designed aluminum base offered in white or black architectural grade finish.

**ADAPATER:** c-CSA-us

**CERTIFIED:**

**CONCEPTION:** Avec son abat-jour de quinze panneaux acoustiques, Mill offre une esthétique et une atmosphère douce améliorant sa fonctionnalité. Mill vous aidera à contrôler le volume sonore de l'espace tout en ajoutant un élément de design époustoufflant au décor. Découpés sur mesure, les panneaux acoustiques en feutre synthétique rigide sont disponibles en 30 couleurs. Composés principalement d'au moins 40% de bouteilles de polyéthylène recyclées (PET), ces panneaux sont recyclables et inodores.

**INSTALLATION:** Positionné magnétiquement n'importe où sur l'ARENA pour faciliter l'installation ou la reconfiguration de l'éclairage sur site. L'adaptateur est muni d'un crochet pour une double sécurité.

**SOURCE LUMINEUSE:** Pourvu d'une source lumineuse de type COB, ce luminaire offre un éclairage uniforme.

**ADAPTATEUR:** Base en aluminium conçu sur mesure offert avec une finition noire ou blanche de grade architectural.

**CERTIFIÉ:** c-CSA-us

# ARENA - ADAPTER TAA / TAB

**ARENA (8200/8220/8210) REQUIS**  
(SOLD SEPARATELY)  
TAA - for Arena 8210 & 8220  
TAB - for Arena 8200

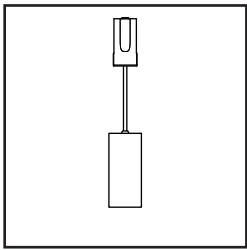
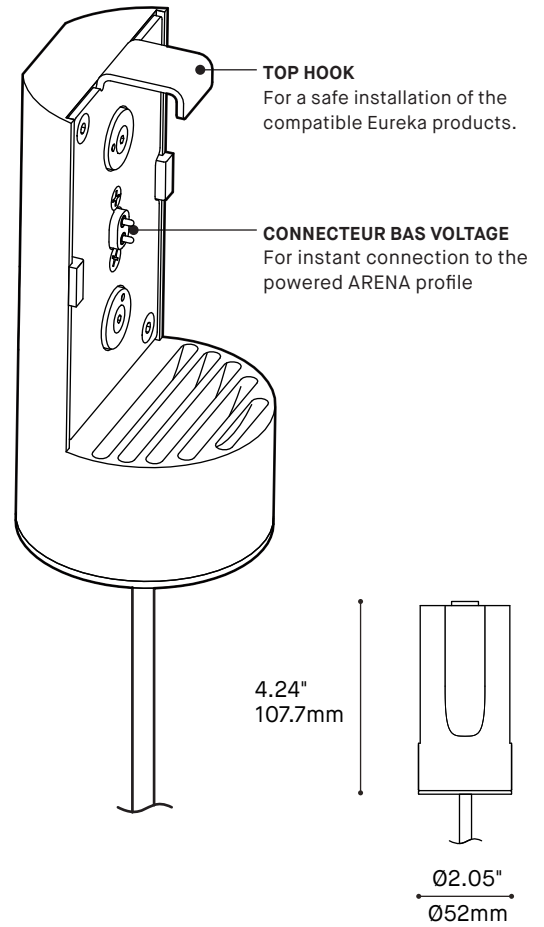
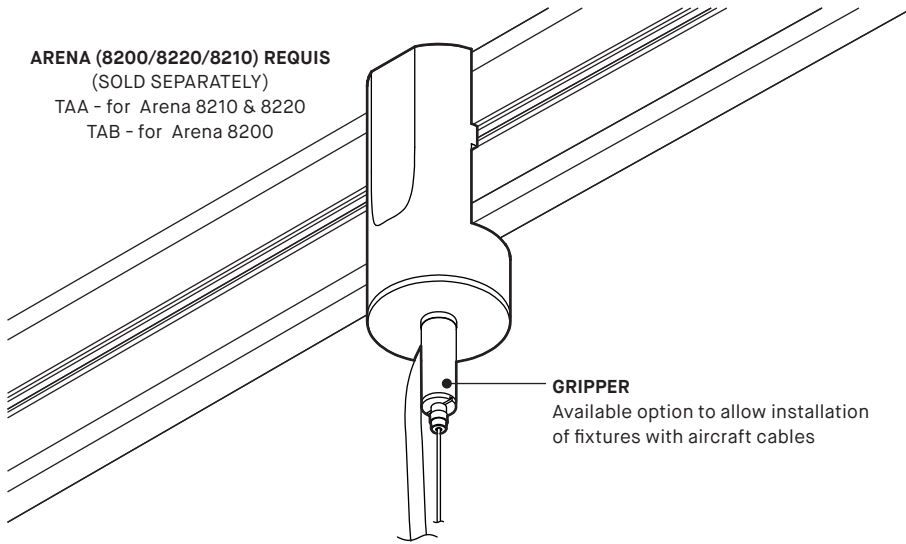

SCOUT

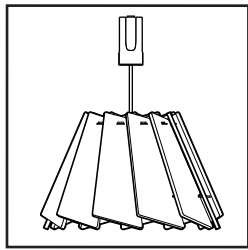

MINI MUTE

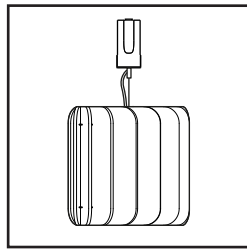

MILL 14"

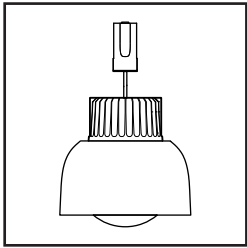

BLOOM

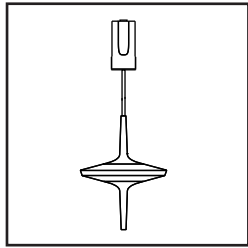

CELESTE

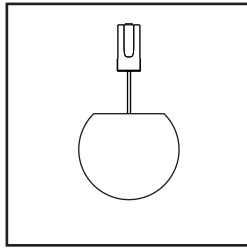

MIKA 8"

### EVEN MORE POSSIBILITIES

This adapter allows multiple Eureka luminaires to be magnetically positioned anywhere on all ARENA structures. For easy installation or on-site reconfiguration of the lighting environment. Cable length is not field adjustable and must be specified to desired length.

### PRODUCT SPECIFICATIONS

SCOUT 4048/4049-XX    MINI MUTE 4258-16    MILL 4277D-14    BLOOM 4269-XX    CELESTE 4010-CEL1    MIKA 3230-8

PERFORMANCE						
SYSTEM WATTAGE	8 W DC	11 W DC	8 W DC	8 W DC	4 W DC	8 W DC
DELIVERED LUMENS (4000K)	855 LM	707 LM	593 LM	605 TO 797 LM	145 LM	806 LM
EFFICACY	111 LM/W	64.8 LM/W	77 LM/W	78.5 TO 103.5 LM/W	34 LM/W	104.5 LM/W
OTHER INFORMATION						
WEIGHT	MAX 6.05 LBS / 2.65 KG	5.83 LBS / 2.65 KG	11.3 LBS / 4.9 KG	MAX 9.75 LBS / 4.43KG	2.2 LBS / 1 KG	2.2 LBS / 1 KG
L70 (LUMEN MAINTENANCE)	63,000 HRS	60,000 HRS	63,600 HRS	55,000 HRS	60,000 HRS	55,000 HRS
WELL & LEED STANDARD REQUIREMENTS (SEE SPECIFIC PRODUCT SPEC SHEET)						

### EFFICACY MULTIPLIERS

CRI	CCT	FACTOR
80+	4000K	1.00
80+	3500K	0.98
80+	3000K	0.94
80+	2700K	0.91
90+	4000K	0.88
90+	3500K	0.85
90+	3000K	0.81
90+	2700K	0.77

### LIGHT DISTRIBUTIONAV

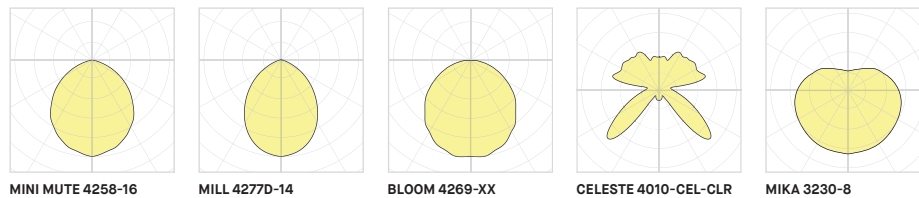

## TECHNICAL DATA

# ARENA - ADAPTATEUR TAA / TAB

**ARENA (8200/8220/8210) REQUIS**  
(VENDU SÉPARÉMENT)  
TAA - pour Arena 8210 & 8220  
TAB - pour Arena 8200

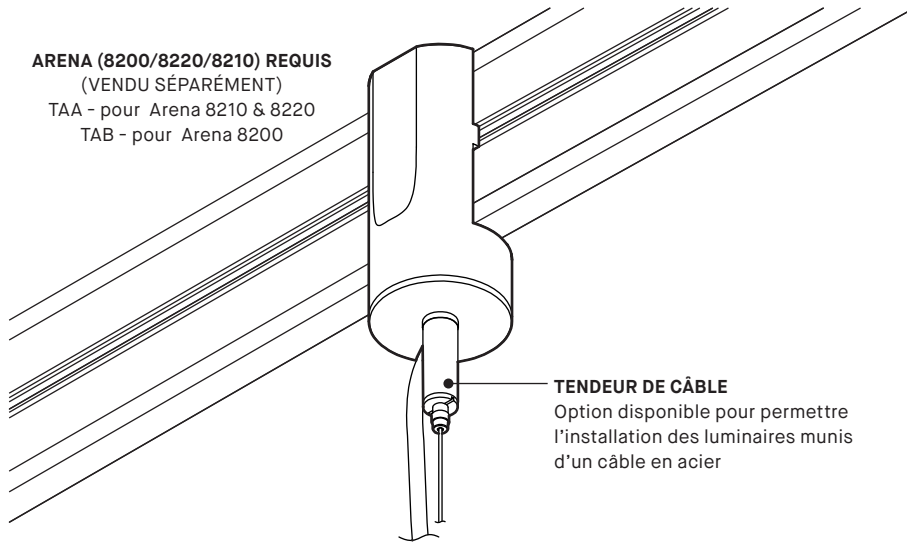

**TENDEUR DE CÂBLE**  
Option disponible pour permettre l'installation des luminaires munis d'un câble en acier

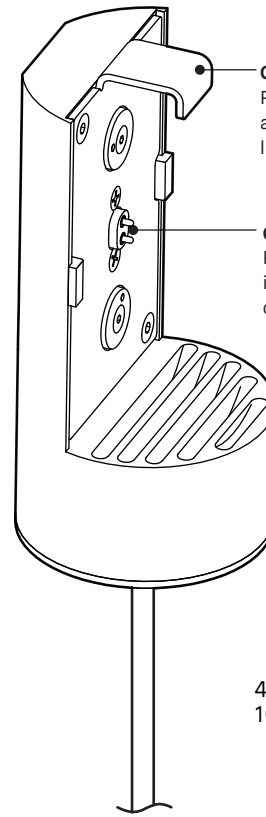

**CROCHET SUPÉRIEUR**  
Pour une installation sécuritaire adaptée au poids des différents luminaires de la gamme Eureka

**CONNECTEUR BAS VOLTAGE**  
Pour une connexion instantanée au profil alimenté du ARENA

4.24"  
107.7mm

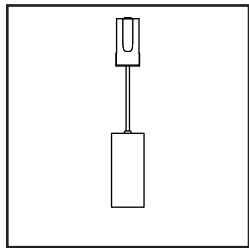
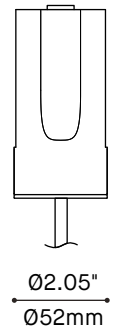

SCOUT

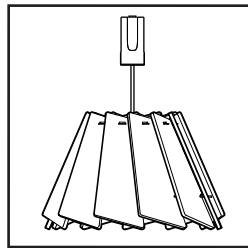

MINI MUTE

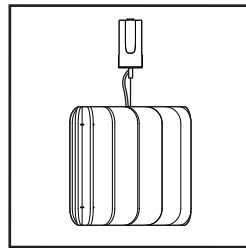

MILL 14"

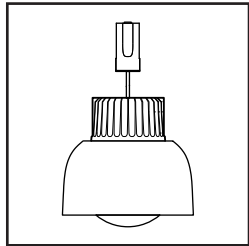

BLOOM

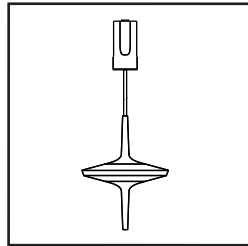

CELESTE

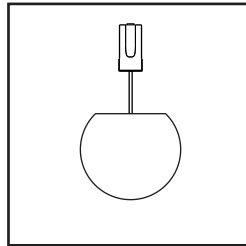

MIKA 8"

### ENCORE PLUS DE POSSIBILITÉS

Grâce à cet adaptateur, de nombreux luminaires Eureka peuvent être positionnés magnétiquement n'importe où sur les différentes structures ARENA.

Pour une installation facile ou une reconfiguration de l'éclairage sur site.

La longueur du câble n'est pas ajustable, la longueur souhaitée doit être spécifiée.

### SPÉCIFICATION SPRODUIT

SCOUT 4048/4049-XX    MINI MUTE 4258-16    MILL 4277D-14    BLOOM 4269-XX    CELESTE 4010-CEL1    MIKA 3230-8

#### PERFORMANCE

PERFORMANCE	SCOUT 4048/4049-XX	MINI MUTE 4258-16	MILL 4277D-14	BLOOM 4269-XX	CELESTE 4010-CEL1	MIKA 3230-8
PUISSANCE TOTALE	8 W DC	11 W DC	8 W DC	8 W DC	4 W DC	8 W DC
LUMENS RÉELS (4000K)	855 LM	707 LM	593 LM	605 TO 797 LM	145LM	806 LM
EFFICACITÉ	111 LM/W	64.8 LM/W	77 LM/W	78.5 TO 103.5 LM/W	34 LM/W	104.5 LM/W

#### AUTRES INFORMATIONS

AUTRES INFORMATIONS	SCOUT 4048/4049-XX	MINI MUTE 4258-16	MILL 4277D-14	BLOOM 4269-XX	CELESTE 4010-CEL1	MIKA 3230-8
POIDS	MAX 6.05 LBS / 2,65 KG	5.83 LBS / 2.65 KG	11.3 LBS / 4.9 KG	MAX 9.75 LBS / 4.43KG	2.2 LBS / 1 KG	2.2 LBS / 1 KG
L70 (LUMEN MAINTENANCE)	63,000 HRS	60,000 HRS	63,600 HRS	55,000 HRS	60,000 HRS	55,000 HRS

CRITÈRES DE CERTIFICATION WELL & LEED (VOIR FICHE TECHNIQUE DU PRODUIT)

### FACTEUR D'EFFICACITÉ

IRC	CCT	FACTEUR
80+	4000K	1.00
80+	3500K	0.98
80+	3000K	0.94
80+	2700K	0.91
90+	4000K	0.88
90+	3500K	0.85
90+	3000K	0.81
90+	2700K	0.77

### DISTRIBUTION LUMINEUSE

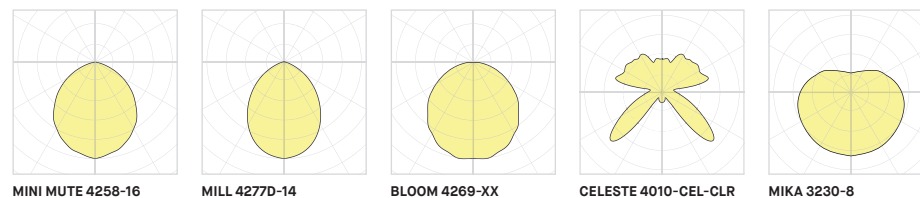

MINI MUTE 4258-16

MILL 4277D-14

BLOOM 4269-XX

CELESTE 4010-CEL-CLR

MIKA 3230-8



Visitez notre site Web pour les termes et conditions.



## DONNÉES TECHNIQUES

# Acoustic Material Color Options for Arena

## Standard colors



**ABF**  
Azure Blue



**AWF**  
Arctic White



**BBF**  
Basic Black



**BOF**  
Blood Orange



**BTF**  
Battleship Gray



**BYF**  
Banana Yellow



**CHF**  
Charcoal

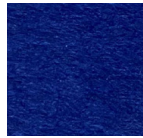

**NBF**  
Navy Blue



**OBF**  
Ocean Blue

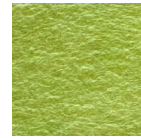

**PGF**  
Pear Green

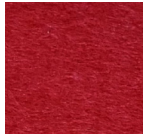

**REF**  
Red



**SGF**  
Silver Gray

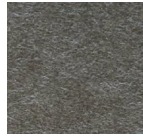

**TGF**  
Titanium Gray



**ZFF**  
Zinfandel

## Premium colors



**BGF**  
Bubble Gum

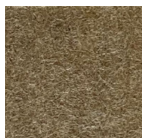

**BKF**  
Bark Brown

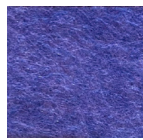

**DBF**  
Denim Blue



**DTF**  
Deep Teal Green



**DYF**  
Daisy Yellow

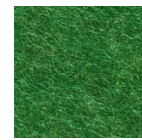

**GGF**  
Grass Green



**LBF**  
Light Beige

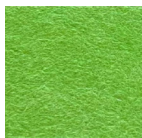

**LGF**  
Lime Green

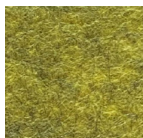

**MGF**  
Moss Green

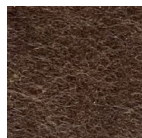

**OAF**  
Oak Brown



**PBF**  
Peanut Brown



**PNF**  
Pinot Noir

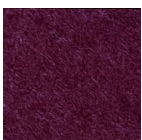

**PPF**  
Plum Purple



**SBF**  
Sky Blue



**TOF**  
Tangerine Orange





**TPF**  
Tulip Purple

- Premium colors carry extended lead times. Additional fees may apply for expedited lead times. Please consult factory.
- Due to the dye process, colors may vary slightly from batch to batch.

# Arena Mapping

MIXING LIGHT SOURCES IS POSSIBLE AND RECOMMENDED. TO HELP YOU DO SO, SUBSTRACT THE DC LOAD OF EACH LIGHT SOURCE FROM THE MAXIMUM DC LOAD OF ARENA. DO NOT EXCEED MAXIMUM WEIGHT PER SIDE

<b>LUMINAIRE</b>	<b>FRAME CONFIGURATION</b> *REFER TO 2D DRAWINGS FOR EACH SIZE.	<b>ARENA RING</b>  8200-36 8200-54	<b>ARENA SQUARE &amp; RECTANGLE</b>			
			8220-36X36 8220-36X54	8220-54X54 8220-36X96 8220-54X96 8220-96X96	8220-36X190 8220-54X190 8220-96X190 8220-190X190	8220-36X380 8220-54X380 8220-96X380 8220-190X380 8220-380X380
	<b>MAXIMUM TOTAL DC LOAD OF ACCESSORY</b>	<b>90W DC</b>	<b>90W DC</b>	<b>180W</b> (90W DC PER 2 SIDES)	<b>360W</b> (90W DC PER SIDES)	<b>540W, 720W</b> (90W DC PER SECTION)
	<b>MAXIMUM TOTAL WEIGHT OF ACCESSORY</b>	<b>25 LBS</b>	<b>25 LBS / SIDE</b>	<b>25 LBS / SIDE</b>	<b>25 LBS / SECTION</b>	<b>25 LBS / SECTION</b>

<b>LUMINAIRE</b>	<b>FRAME CONFIGURATION</b> *REFER TO 2D DRAWINGS FOR EACH SIZE.	<b>ARENA STRAIGHT</b>			
		8210-36 (1 SECTION) 8210-54 (1 SECTION) 8210-70 (2 SECTIONS)	8210-96 (1 SECTION) 8210-158 (3 SECTIONS) 8210-190 (2 SECTIONS)	8210-284 (3 SECTIONS) 8210-380 (4 SECTIONS)	
		<b>MAXIMUM TOTAL DC LOAD OF ACCESSORY</b>	<b>90W (90W DC FOR BOTH SIDES)</b>	<b>180W (90W DC PER SECTION)</b>	<b>360W DC (90W DC PER SECTION)</b>
	<b>MAXIMUM TOTAL WEIGHT OF ACCESSORY</b>	<b>25 LBS / SECTION</b>	<b>25 LBS / SECTION</b>	<b>25 LBS / SECTION</b>	

<b>ACCESSORIES HEAD</b>	<b>LIGHT SOURCES</b>	<b>BEAM</b> 8290	<b>GLOW</b> 8291	<b>AIM</b> 8292	<b>CONE</b> 8294	<b>BALL</b> 8295
						
	<b>DC LOAD</b>	<b>8W DC</b>	<b>8W DC</b>	<b>8W DC</b>	<b>11W DC</b>	<b>8W DC</b>
	<b>WEIGHT LBS</b>	<b>0.62 LBS</b>	<b>0.70 LBS</b>	<b>0.61 LBS</b>	<b>0.88 LBS</b>	<b>0.48 LBS</b>

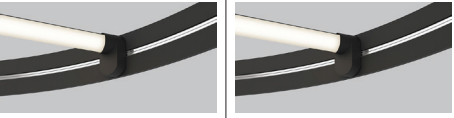
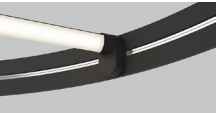
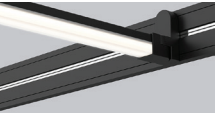
<b>ACCESSORIES SLICE</b>	<b>LIGHT SOURCES</b>	<b>SLICE-ROUND 8293 (ONLY FOR 8200)</b>		<b>SLICE-SQUARE 8296</b>	
		8293-36	8293-54	8296-36	8296-54
					
	<b>DC LOAD</b>	<b>8W DC</b>	<b>11W DC</b>	<b>8W DC</b>	<b>11W DC</b>
<b>WEIGHT LBS</b>	<b>1.24 LBS</b>	<b>1.65 LBS</b>	<b>2.22 LBS</b>	<b>3.50 LBS</b>	

<b>ACCESSORIES ADAPTER</b>	<b>LIGHT SOURCES</b>	<b>MILL 14"</b> 4277D-14	<b>SCOUT 02.75"</b> 4048-XX	<b>SCOUT 04"</b> 4049-XX	<b>MIKA 8"</b> 4230-8	<b>BLOOM</b> 4269-XX	<b>MINI MUTE</b> 4258-16	<b>CELESTE</b> 4010-CEL1
								
	<b>DC LOAD</b>	<b>8W DC</b>	<b>8W DC</b>	<b>8W DC</b>	<b>8W DC</b>	<b>8W DC</b>	<b>11W DC</b>	<b>4W DC</b>
	<b>WEIGHT LBS</b>	<b>11.3 LBS</b>	<b>MAX 4.32 LBS</b>	<b>MAX 6.05 LBS</b>	<b>2.40 LBS</b>	<b>MAX 9.75 LBS</b>	<b>5.83 LBS</b>	<b>2.20 LBS</b>

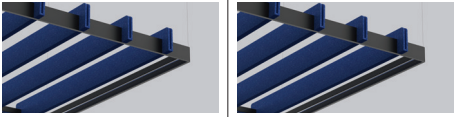
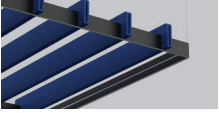
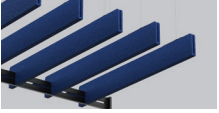
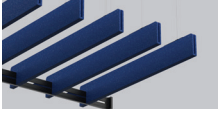
<b>ACCESSORIES ACOUSTIC</b>	<b>ACOUSTIC CONFIGURATION</b>	<b>ACOUSTIC BAFFLE FOR ARENA SQUARE</b>		<b>ACOUSTIC BAFFLE FOR ARENA STRAIGHT</b>	
		8297-40	8297-58	8298-40	8298-58
					
	<b>WEIGHT LBS</b>	<b>1.38 LBS / PANEL</b>	<b>1.63 LBS / PANEL</b>	<b>1.38 LBS / PANEL</b>	<b>1.63 LBS / PANEL</b>
<b>CONFIGURATION USE FOR ARENA</b>	8220-36X36 8220-36X54 8220-36X96	8220-54X54 8220-36X54 8220-54X96	8210-XX 8220-XX	8210-XX 8220-XX	

\*WE RESERVE THE RIGHT TO MODIFY ANY INFORMATION AT ANY TIME.

# ARENA 8200

PROJECT PROJÉT
SPEC TYPE
NOTES

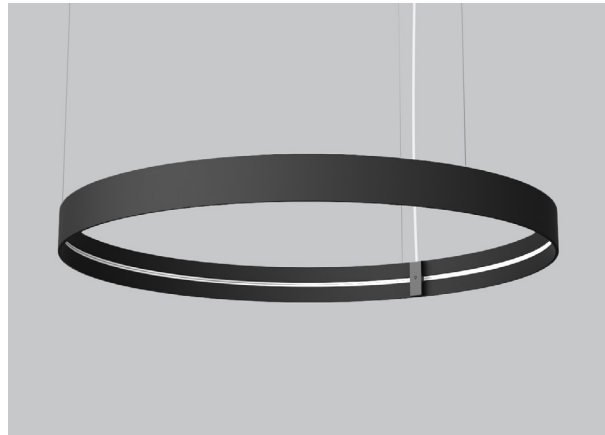

## FAMILY FAMILLE



## MOUNTING OPTIONS OPTIONS DE MONTAGE

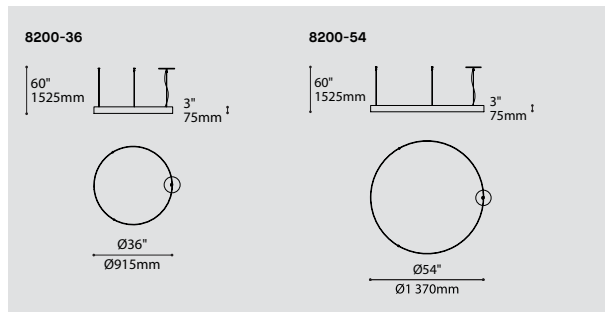
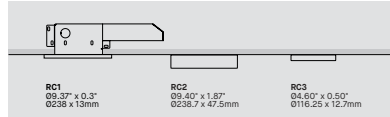

## ORDERING SPECIFICATION SPÉCIFICATION DE COMMANDE

CODE

### MODEL MODÈLE

**8200-36** ARENA 36"  
**8200-54** ARENA 54"

### MAXIMUM DC LOAD PUISSANCE MAXIMALE DC

**90W** 90 WATT DC  
 TOTAL DC LOAD OF INSTALLED LIGHT SOURCES MUST NOT EXCEED 90W. (see mapping page)

RING
ARENA 8200-36 & 8200-54
MAXIMUM DC LOAD 90W

LIGHT SOURCES				
BEAM 8290	GLOW 8291	AIM 8292	SLICE RD 8293-36	SLICE RD 8293-54
8W DC	8W DC	8W DC	8W DC	11W DC

### VOLTAGE VOLTAGE

**120V** 120 VOLT  
**277V** 277 VOLT

### CONTROL OPTION OPTION DE CONTRÔLE

**DV** 0-10V DIMMING (120V-277V)  
**NLTAIR2\*** NLIGHT AIR CONTROL GEN 2 (NOT AVAILABLE WITH MOUNTING OPTION RC3)  
**NLIGHT\*** NLIGHT WIRED CONTROL (NOT AVAILABLE WITH MOUNTING OPTION RC3)  
 LED DIMMING DRIVER IS STANDARD IN THIS PRODUCT  
 \*NLIGHT INTEGRATION REQUIRES A REMOTE POWER PACK (39NLAA & 39NLWA AS BELOW FOR NLIGHT). REFER TO NLIGHT GUIDE AND INSTALLATION SHEET FOR ALL REQUIREMENTS.

### DRIVER POSITION POSITION DE L'ALIMENTATION

**RDP \*** RECESSED DRIVER  
 \* 3981C IS REQUIRED

### CABLE CÂBLE

**AC** AIRCRAFT MOUNTING & CLEAR CABLE, FIELD ADJUSTABLE

### CABLE LENGTH LONGUEUR DE CÂBLE

**60** 60" AIRCRAFT CABLE (STD LENGTH)  
**\*\*** CUSTOM AIRCRAFT CABLE LENGTH (PLEASE SPECIFY)  
 FOR OVERALL LENGTH, PLEASE CONTACT YOUR EUREKA REPRESENTATIVE.

### MOUNTING MONTAGE

**RC1** ROUND CANOPY ON JBOX FOR RECESSED DRIVERS 0.5" (2475C)  
**RC2** ROUND SURFACE SCREWLESS CANOPY 1.87" (2475I)  
**RC3** ROUND SURFACE SCREWLESS CANOPY 0.50" FOR REMOTE DRIVER BOX 12"X16" (2471C)  
 \* PAIR WITH ACCESSORY 3981GA

### MOUNTING CABLE OPTION OPTION DE MONTAGE DE CÂBLE

IF NO OPTION IS SELECTED, AN OFF-CENTERED ROUND CANOPY WITH STRAIGHT AIRCRAFT CABLES IS STANDARD  
**RCC** CENTERED ROUND CANOPY - STRAIGHT AIRCRAFT CABLES

### CANOPY FINISH FINI PAVILLON

**BLKE** BLACK FINE TEXTURE  
**WHE** WHITE FINE TEXTURE

### POWER CORD FINISH FINI CÂBLE D'ALIMENTATION

**BLK** BLACK POWER CORD  
**WH** WHITE POWER CORD  
**CLR** CLEAR POWER CORD

### RING FINISH FINI DE L'ANNEAU

**BLKE** BLACK FINE TEXTURE  
**WHE** WHITE FINE TEXTURE

### ACCESSORY ACCESSOIRE

**3981C** JUNCTION BOX FOR RECESSED DRIVER OPTION SQ1 OR RC1  
**3981GA** REMOTE DRIVER BOX 12"X16" FOR MOUNTING RC3 FOR DC LOAD 90W  
**39NLAA\*** NLIGHT AIR GEN 2 REMOTE CONTROLLER (NOT AVAILABLE WITH MOUNTING OPTION RC3)  
**39NLWA\*** NLIGHT WIRED REMOTE CONTROLLER (NOT AVAILABLE WITH MOUNTING OPTION RC3)  
 \* FOR CHICAGO PLENUM INSTALLATION, PLEASE CONTACT YOUR EUREKA REPRESENTATIVE.



SPECIFICATION

# ARENA STRAIGHT 8210

PROJECT PROJÉT
SPEC TYPE
NOTES

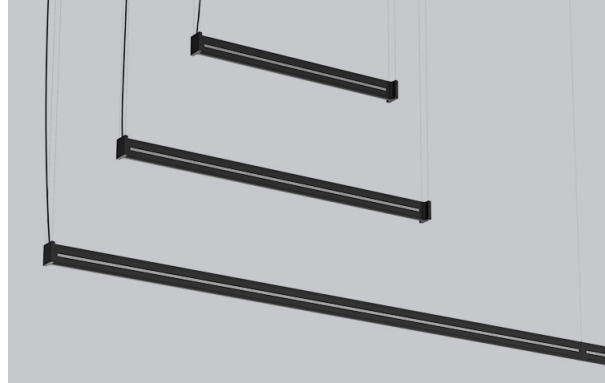

## FINISH FINI

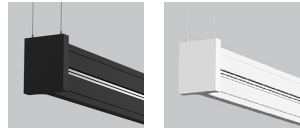

BLKE

WHE

## FAMILY FAMILLE



ARENA - BEAM 8290

ARENA - GLOW 8291

ARENA - AIM 8292

ARENA - BALL 8295



ARENA - CONE 8294

ARENA - SLICE SQ 8296

ARENA - ACOUSTIC 8298

## MOUNTING CABLE OPTION OPTION DE MONTAGE DE CÂBLE

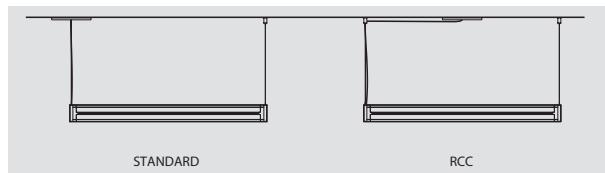

STANDARD

RCC

## MOUNTING OPTION OPTION DE MONTAGE

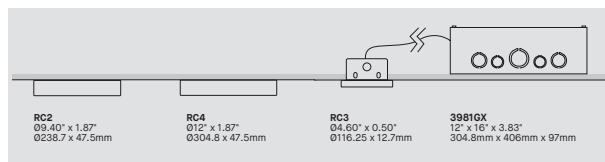

RC2  
09.407 x 1.87  
0238.7 x 47.5mm

RC4  
012.1 x 1.87  
0304.8 x 47.5mm

RC3  
04.60 x 0.50  
0116.25 x 12.7mm

3981GX  
12 x 10 x 3.83  
304.8mm x 406mm x 97mm

## ORDERING SPECIFICATION SPÉCIFICATION DE COMMANDE

## CODE

### STANDARD MODEL MODÈLE STANDARD

8210-36	ARENA STRAIGHT 36"
8210-54	ARENA STRAIGHT 54"
8210-70	ARENA STRAIGHT 70" (2 SECTIONS CONNECTED WITH 1 JOINER)
8210-96	ARENA STRAIGHT 96"
8210-158	ARENA STRAIGHT 158" (3 SECTIONS CONNECTED WITH 2 JOINERS)
8210-190	ARENA STRAIGHT 190" (2 SECTIONS CONNECTED WITH 1 JOINER)
8210-285	ARENA STRAIGHT 285" (3 SECTIONS CONNECTED WITH 2 JOINERS)
8210-380	ARENA STRAIGHT 380" (4 SECTIONS CONNECTED WITH 3 JOINERS)

FOR CUSTOM SIZES, PLEASE CONTACT YOUR EUREKA REPRESENTATIVE.

### DC LOAD PUISSANCE MAXIMALE DC

90W	1X 90 WATT (AVAILABLE FROM 36" TO 96")
180W	2X 90 WATT (AVAILABLE FROM 36" TO 190")
360W	4X 90 WATT (ONLY AVAILABLE FOR 285" TO 380")

ARENA STRAIGHT 8210	LIGHT SOURCES							ADAPTER TAA
	BEAM 8290	GLOW 8291	AIM 8292	SLICE-SQ 8296-36	SLICE-SQ 8296-54	BALL 8295	CONE 8294	
MAXIMUM DC LOAD 90W, 180W, 360W	8W DC	8W DC	8W DC	8W DC	11W DC	8W DC	11W DC	SEE SPEC SHEET
MAXIMUM TOTAL WEIGHT PER SECTION 25 LBS	0.62 LBS	0.70 LBS	0.61 LBS	2.22 LBS	3.50 LBS	0.48 LBS	0.88 LBS	

### VOLTAGE VOLTAGE

120V	120 VOLT
277V	277 VOLT

### CONTROL OPTIONS OPTION DE CONTRÔLE

DV	0-10V DIMMING (120V-277V)
NLTAIR2*	NLIGHT AIR CONTROL GEN2 (NOT AVAILABLE WITH MOUNTING OPTION RC3)
NLIGHT*	NLIGHT WIRED CONTROL (NOT AVAILABLE WITH MOUNTING OPTION RC3)

LED DIMMING DRIVER IS STANDARD IN THIS PRODUCT  
\*NLIGHT INTEGRATION REQUIRES A REMOTE POWER PACK (39NLAA & 39NLWA AS BELOW FOR NLIGHT). REFER TO NLIGHT GUIDE AND INSTALLATION SHEET FOR ALL REQUIREMENTS.

### CABLE CÂBLE

AC	AIRCRAFT CABLE & POWER CORD, FIELD ADJUSTABLE
----	---

### CABLE LENGTH LONGUEUR DE CÂBLE

60	60" AIRCRAFT CABLE (STD LENGTH)
**	CUSTOM AIRCRAFT CABLE LENGTH (PLEASE SPECIFY)

FOR OVERALL LENGTH, PLEASE CONTACT YOUR EUREKA REPRESENTATIVE.

### MOUNTING MONTAGE

RC2	ROUND SURFACE SCREWLESS CANOPY 9.4" FOR 90W ONLY (2475I)
RC3	ROUND SURFACE SCREWLESS CANOPY 4.6" FOR REMOTE DRIVER BOX 12"x16" (2471C) (PAIR WITH ACCESSORY 3981GA OR 3981GB)
RC4	ROUND SURFACE SCREWLESS CANOPY 12" FOR 180W OR 360W (2477I)

### MOUNTING CABLE OPTION OPTION DE MONTAGE DE CÂBLE

RCC	FLOATING CANOPY - STRAIGHT AIRCRAFT CABLES IF NO OPTION IS SELECTED, A CANOPY AT END OF THE FIXTURE WITH AIRCRAFT CABLES IS STANDARD
-----	---

### CANOPY & GRIPPERS FINISH FINI PAVILLON ET ATTACHES

BLKE	BLACK FINE TEXTURE
WHE	WHITE FINE TEXTURE

### POWER CORD FINISH FINI CÂBLE D'ALIMENTATION

BLK	BLACK POWER CORD
WH	WHITE POWER CORD
CLR	CLEAR POWER CORD

### FRAME FINISH FINI DU CADRE

BLKE	BLACK FINE TEXTURE
WHE	WHITE FINE TEXTURE

### ACCESSORY ACCESSOIRE

3981GA	1 REMOTE DRIVER BOX 12"x16" FOR MOUNTING RC3 FOR DC LOAD 90W
3981GB	1 REMOTE DRIVER BOX 12"x16" FOR MOUNTING RC3 FOR DC LOAD 180W
3981GB2	2 REMOTE DRIVER BOXES 12"x16" FOR MOUNTING RC3 FOR DC LOAD 360W
39NLAA*	NLIGHT AIR GEN 2 REMOTE CONTROLLER (NOT AVAILABLE WITH MOUNTING OPTION RC3)
39NLWA*	NLIGHT WIRED REMOTE CONTROLLER (NOT AVAILABLE WITH MOUNTING OPTION RC3)

\* FOR CHICAGO PLENUM INSTALLATION, PLEASE CONTACT YOUR EUREKA REPRESENTATIVE



## SPECIFICATION

# ARENA STRAIGHT 8210

## CONFIGURATIONS

**8210-36**  
ARENA STRAIGHT 36"

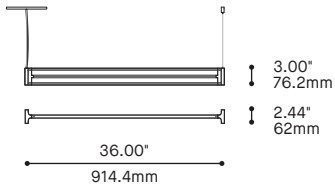

**8210-54**  
ARENA STRAIGHT 54"

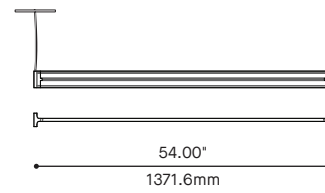

**8210-70**  
ARENA STRAIGHT 70.4"

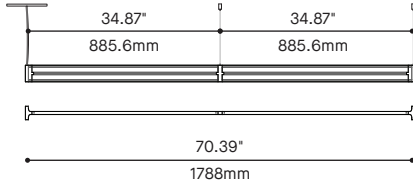

**8210-96**  
ARENA STRAIGHT 96"

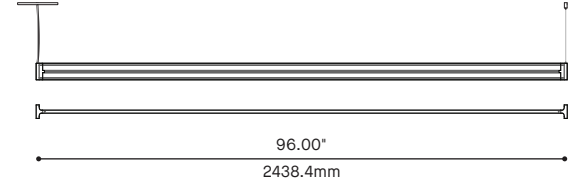

**8210-158**  
ARENA STRAIGHT 158.78"

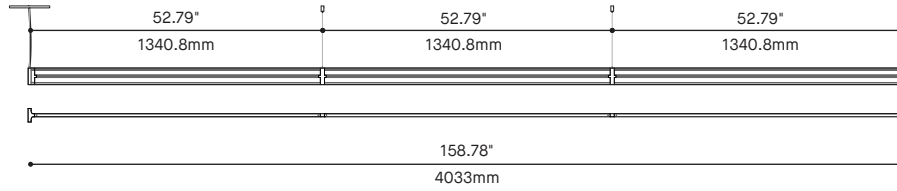

**8210-190**  
ARENA STRAIGHT 190.39"

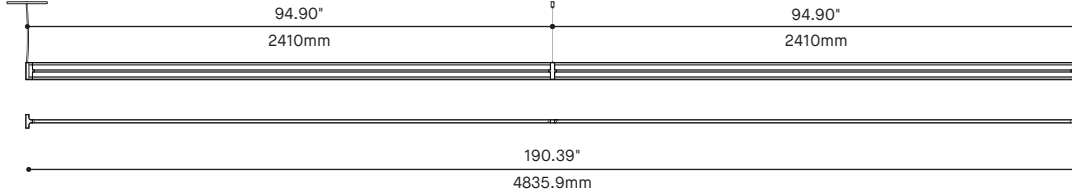

**8210-284**  
ARENA STRAIGHT 284.7"

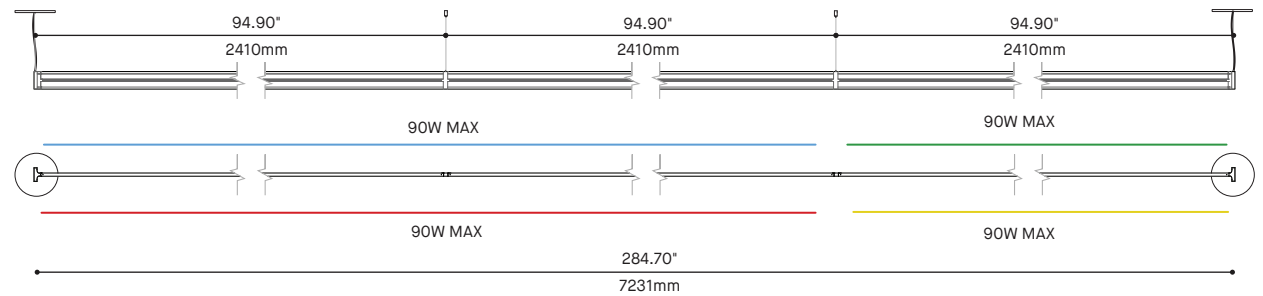

**8210-380**  
ARENA STRAIGHT 379.6"

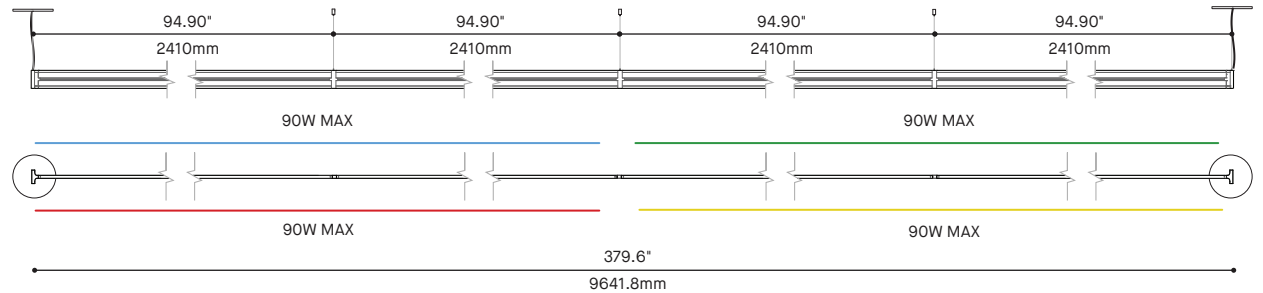



# ARENA SQUARE & RECTANGLE 8220

PROJECT PROJÉT
SPEC TYPE
NOTES

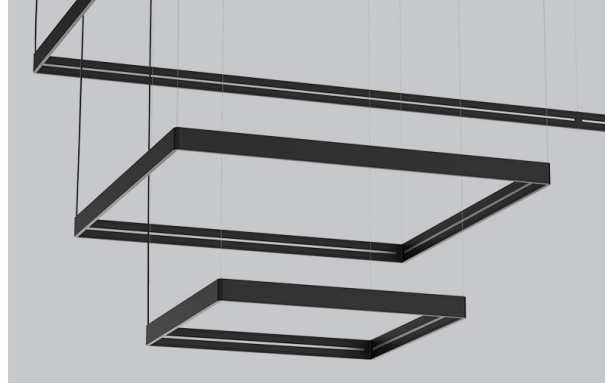

## FINISH FINI

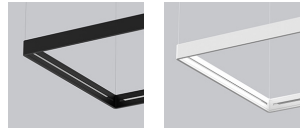

BLKE

WHE

## FAMILY FAMILLE



ARENA - BEAM 8290

ARENA - GLOW 8291

ARENA - AIM 8292

ARENA - BALL 8295

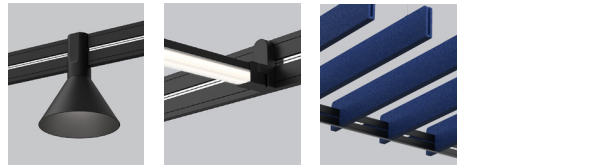

ARENA - CONE 8294

ARENA - SLICE SQ 8296

ARENA - ACOUSTIC 8298

## MOUNTING CABLE OPTION OPTION DE MONTAGE DE CÂBLE

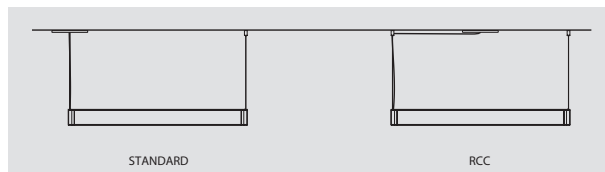

STANDARD

RCC

## ORDERING SPECIFICATION SPÉCIFICATION DE COMMANDE

CODE

### STANDARD MODEL MODÈLE STANDARD

8220-36X36	ARENA SQUARE 36X36"	8220-36X190	ARENA RECTANGLE 36X190"
8220-54X54	ARENA SQUARE 54X54"	8220-54X190	ARENA RECTANGLE 54X190"
8220-96X96	ARENA SQUARE 96X96"	8220-96X190	ARENA RECTANGLE 96X190"
8220-190X190	ARENA SQUARE 190X190"	8220-36X380	ARENA RECTANGLE 36X380"
8220-380X380	ARENA SQUARE 380X380"	8220-54X380	ARENA RECTANGLE 54X380"
8220-36X54	ARENA RECTANGLE 36X54"	8220-96X380	ARENA RECTANGLE 96X380"
8220-36X96	ARENA RECTANGLE 36X96"	8220-190X380	ARENA RECTANGLE 190X380"
8220-54X96	ARENA RECTANGLE 54X96"		

FOR CUSTOM SIZES, PLEASE CONTACT YOUR EUREKA REPRESENTATIVE.

### DC LOAD PUISSANCE MAXIMALE DC

90W	1 CANOPY / 1 DRIVER OF 90W
180W	1 CANOPY / 2 DRIVERS OF 90W
360W	2 CANOPY / 4 DRIVERS OF 90W
540W	4 CANOPY / 6 DRIVERS OF 90W
720W	4 CANOPY / 8 DRIVERS OF 90W

8220	36"	54"	96"	190"	380"
36"	90W				
54"		180W			
96"			180W	360W	540W
190"					
380"					720W

ARENA
SQUARE 8220
MAXIMUM DC LOAD SEE TABLE
MAXIMUM TOTAL WEIGHT PER SECTION 25 LBS

LIGHT SOURCES							
BEAM 8290	GLOW 8291	AIM 8292	SLICE-SQ 8296-36	SLICE-SQ 8296-54	BALL 8295	CONE 8294	ADAPTER TAA
8W DC	8W DC	8W DC	8W DC	11W DC	8W DC	11W DC	SEE SPEC SHEET
0.62 LBS	0.70 LBS	0.61 LBS	2.22 LBS	3.50 LBS	0.48 LBS	0.88 LBS	

### VOLTAGE VOLTAGE

120V	120 VOLT
277V	277 VOLT

### CONTROL OPTIONS OPTION DE CONTRÔLE

DV	0-10V DIMMING (120V-277V)
NLTAIR2*	NLIGHT AIR CONTROL GEN2 (NOT AVAILABLE WITH MOUNTING OPTION RC3)
NLIGHT*	NLIGHT WIRED CONTROL (NOT AVAILABLE WITH MOUNTING OPTION RC3)
	LED DIMMING DRIVER IS STANDARD IN THIS PRODUCT
	*NLIGHT INTEGRATION REQUIRES A REMOTE POWER PACK (39NLAA & 39NLWA AS BELOW FOR NLIGHT). REFER TO NLIGHT GUIDE AND INSTALLATION SHEET FOR ALL REQUIREMENTS.

### CABLE CÂBLE

AC	AIRCRAFT CABLE & POWER CORD, FIELD ADJUSTABLE
----	---

AC

### CABLE LENGTH LONGUEUR DE CÂBLE

60	60" AIRCRAFT CABLE (STD LENGTH)
**	CUSTOM AIRCRAFT CABLE LENGTH (PLEASE SPECIFY)
	FOR OVERALL LENGTH, PLEASE CONTACT YOUR EUREKA REPRESENTATIVE.

### MOUNTING MONTAGE

RC2	ROUND SURFACE SCREWLESS CANOPY 9.4" FOR 90W ONLY (24751)
RC3	ROUND SURFACE SCREWLESS CANOPY 4.6" FOR REMOTE DRIVER BOX 12"X16" (2471C) (PAIR WITH ACCESSORY 3981GA OR 3981GB)
RC4	ROUND SURFACE SCREWLESS CANOPY 12" FOR 180W OR 360W (24771)

### MOUNTING CABLE OPTION OPTION DE MONTAGE DE CÂBLE

RCC	FLOATING CANOPY - STRAIGHT AIRCRAFT CABLES
	IF NO OPTION IS SELECTED, A CANOPY AT CORNERS OF THE FIXTURE WITH AIRCRAFT CABLES IS STANDARD

### CANOPY & GRIPPERS FINISH FINI PAVILLON ET ATTACHES

BLKE	BLACK FINE TEXTURE
WHE	WHITE FINE TEXTURE

### POWER CORD FINISH FINI CÂBLE D'ALIMENTATION

BLK	BLACK POWER CORD
WH	WHITE POWER CORD
CLR	CLEAR POWER CORD

### FRAME FINISH FINI DU CADRE

BLKE	BLACK FINE TEXTURE
WHE	WHITE FINE TEXTURE

## MOUNTING OPTION OPTION DE MONTAGE

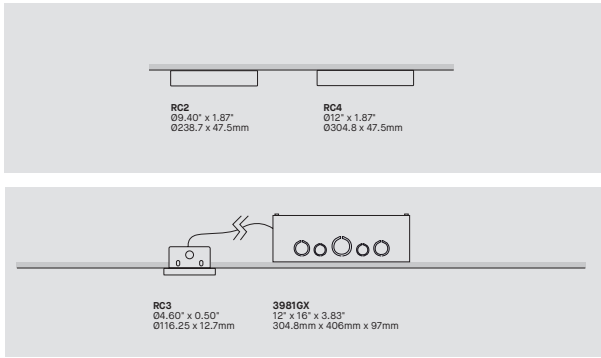

## ACCESSORY ACCESSOIRE

- 3981GA** 1 REMOTE DRIVER BOX 12"X16" FOR MOUNTING RC3 FOR DC LOAD 90W
- 3981GB** 1 REMOTE DRIVER BOX 12"X16" FOR MOUNTING RC3 FOR DC LOAD 180W
- 3981GB2** 2 REMOTE DRIVER BOXES 12"X16" FOR MOUNTING RC3 FOR DC LOAD 360W
- 3981GB3** 3 REMOTE DRIVER BOXES 12"X16" FOR MOUNTING RC3 FOR DC LOAD 540W
- 3981GB4** 4 REMOTE DRIVER BOXES 12"X16" FOR MOUNTING RC3 FOR DC LOAD 720W
- 39NLAA\*** NLIGHT AIR GEN 2 REMOTE CONTROLLER (NOT AVAILABLE WITH MOUNTING OPTION RC3)
- 39NLWA\*** NLIGHT WIRED REMOTE CONTROLLER (NOT AVAILABLE WITH MOUNTING OPTION RC3)

\* FOR CHICAGO PLENUM INSTALLATION, PLEASE CONTACT YOUR EUREKA REPRESENTATIVE

# ARENA SQUARE 8220

## CONFIGURATIONS

**8220-36X36**  
ARENA SQUARE 36" x 36"

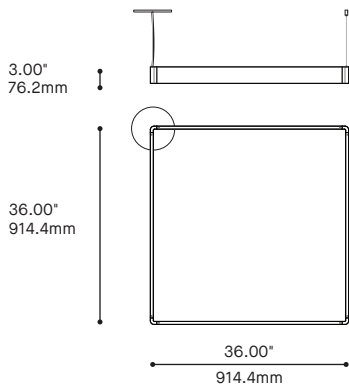

**8220-54X54**  
ARENA SQUARE 54" x 54"

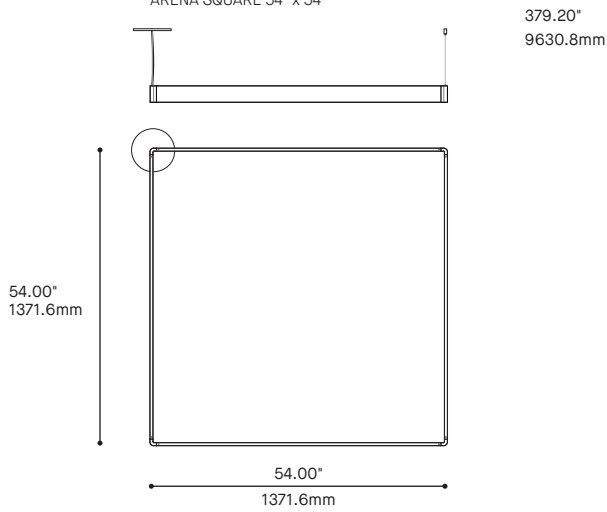

**8220-96X96**  
ARENA SQUARE 96" x 96"

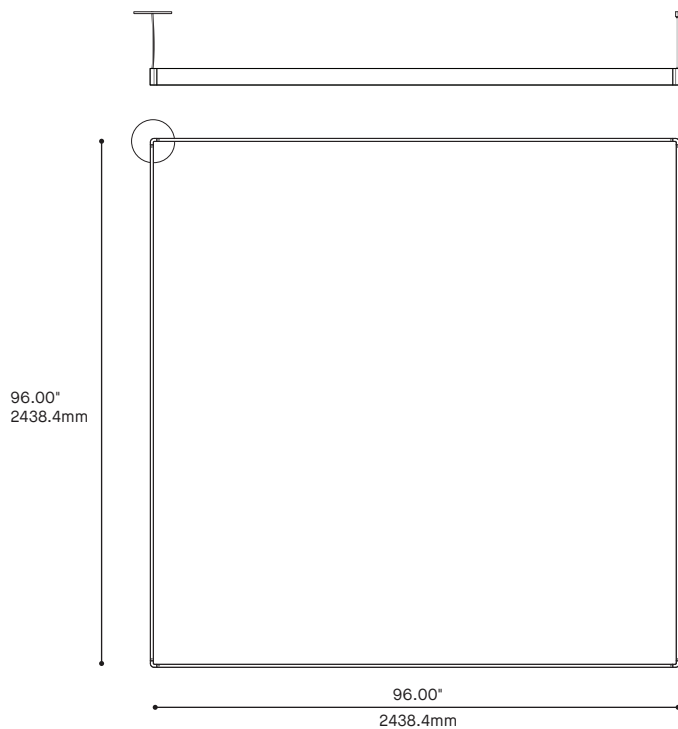

**8220-380X380**  
ARENA SQUARE 380" x 380"

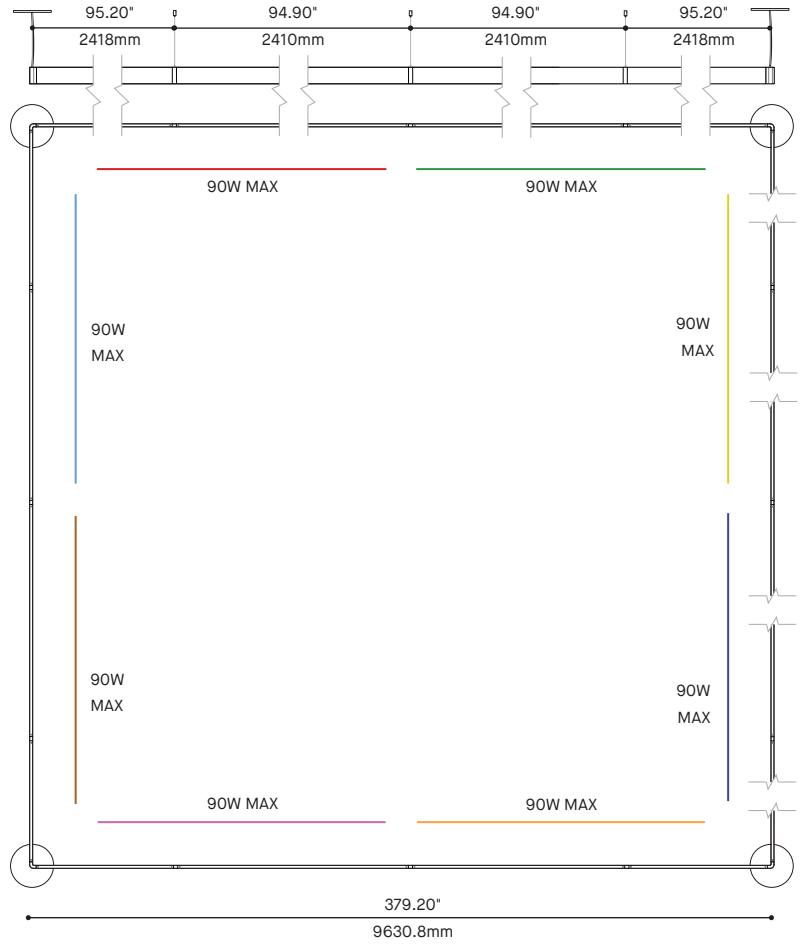

**8220-190X190**  
ARENA SQUARE 190" x 190"

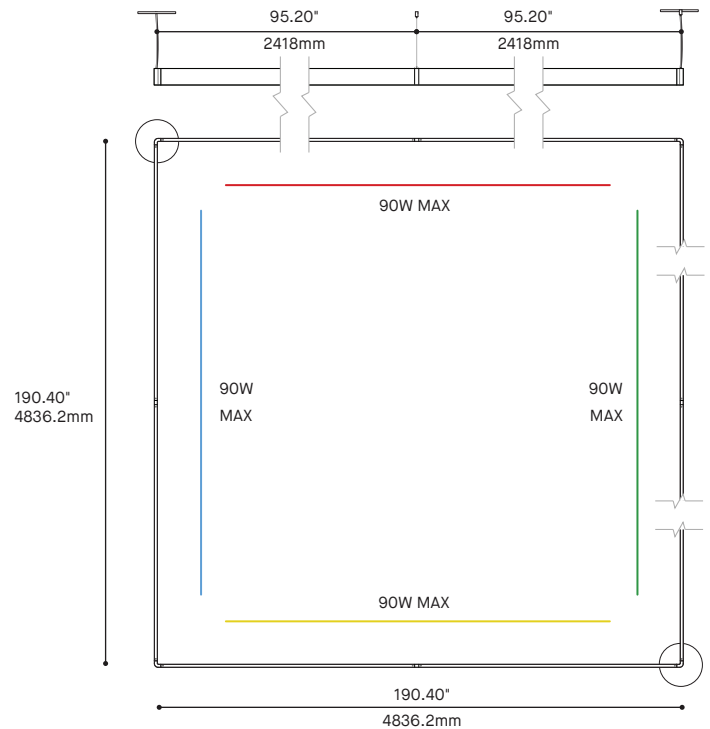

# ARENA RECTANGLE 8220 1/2

## CONFIGURATIONS

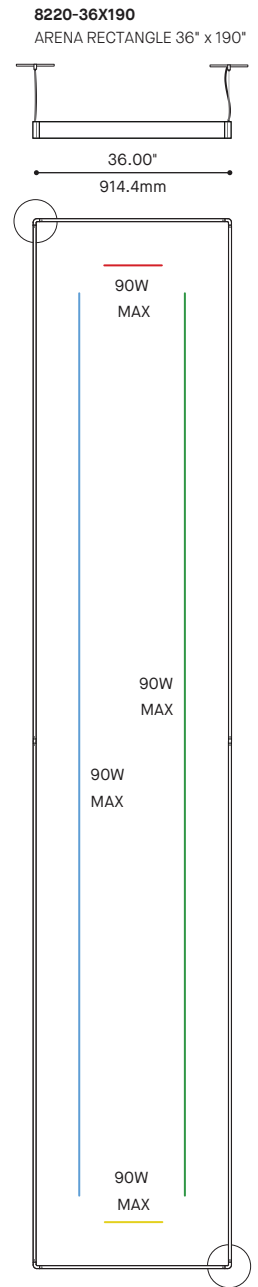
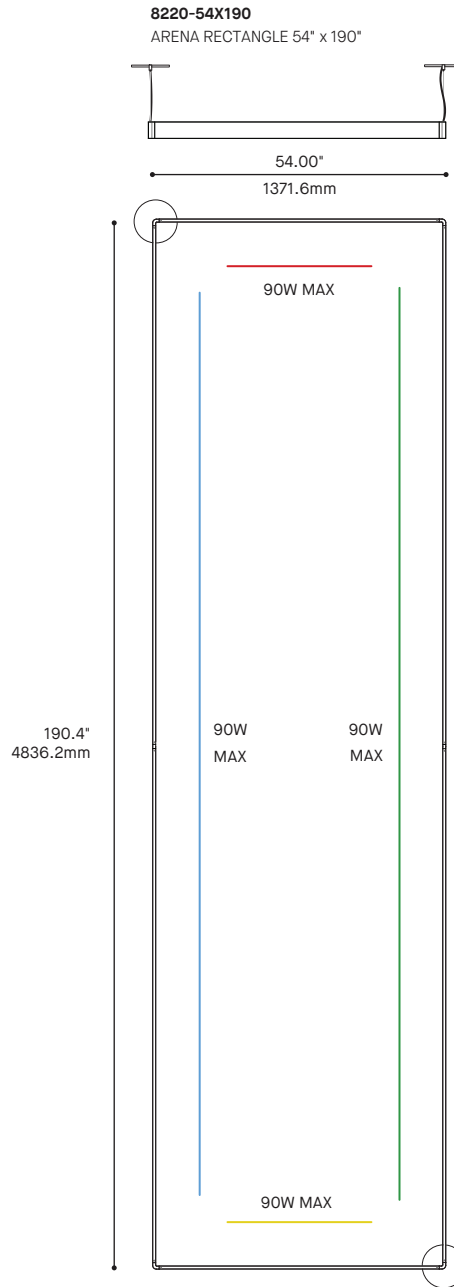
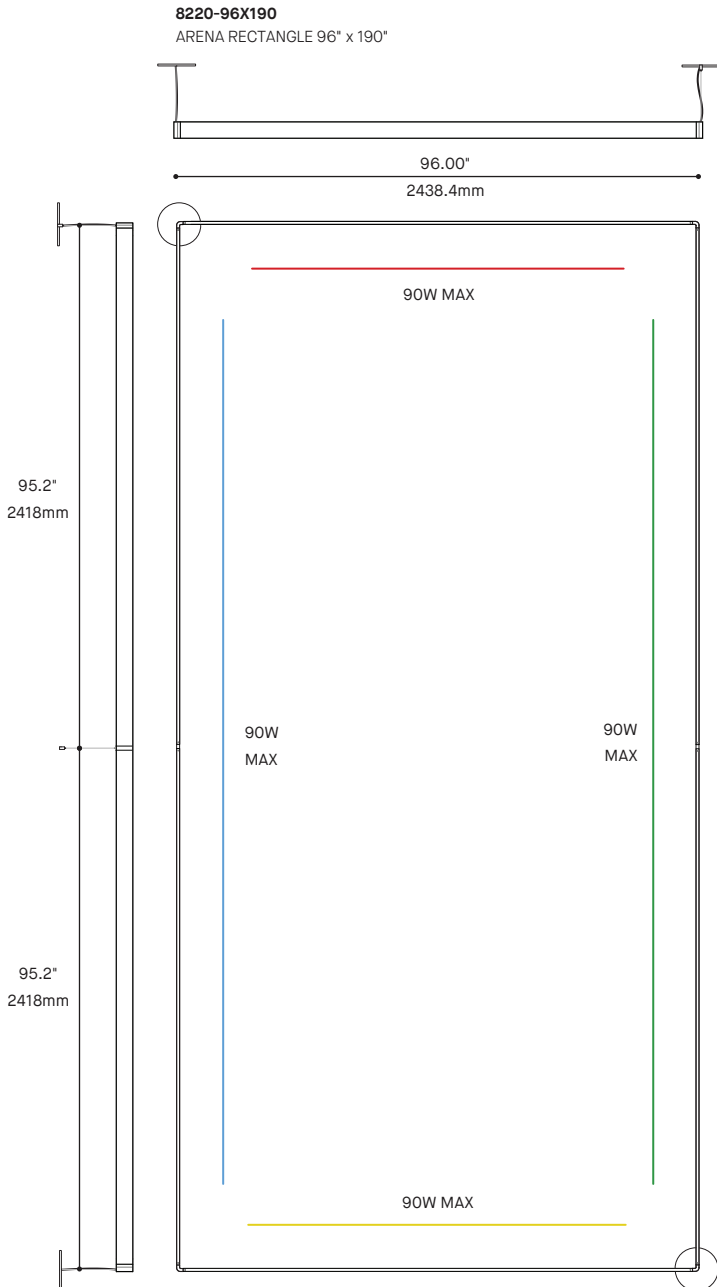
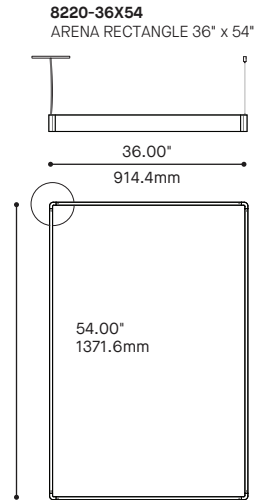
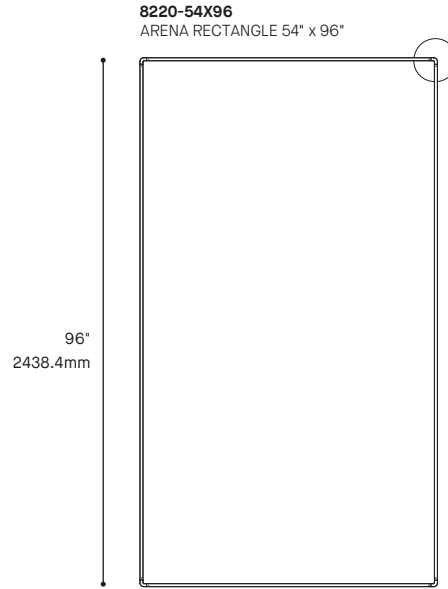
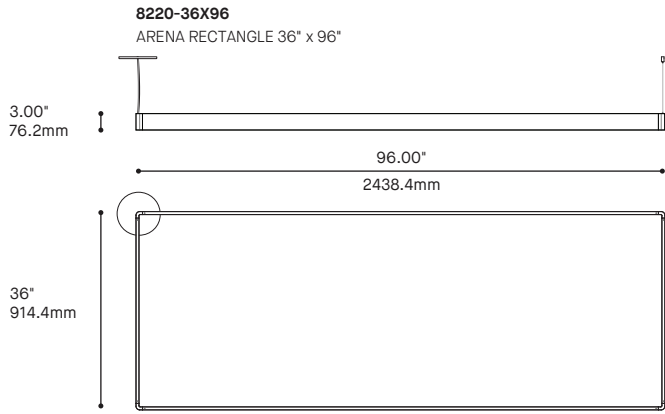

# ARENA RECTANGLE 8220 2/2

## CONFIGURATIONS

**8220-96X380**  
ARENA SQUARE 96" x 380"

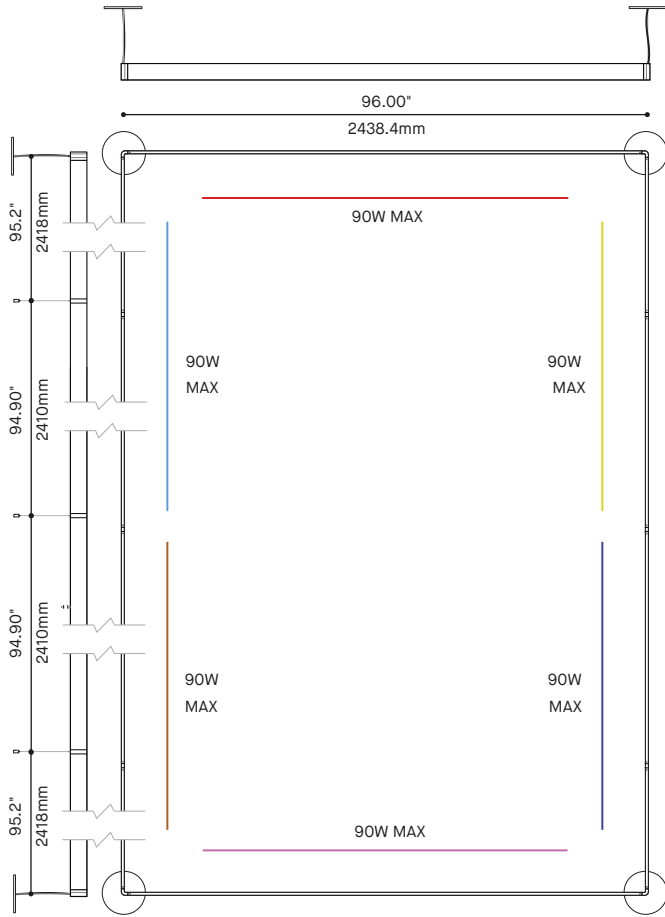

**8220-54X380**  
ARENA RECTANGLE 54" x 380"

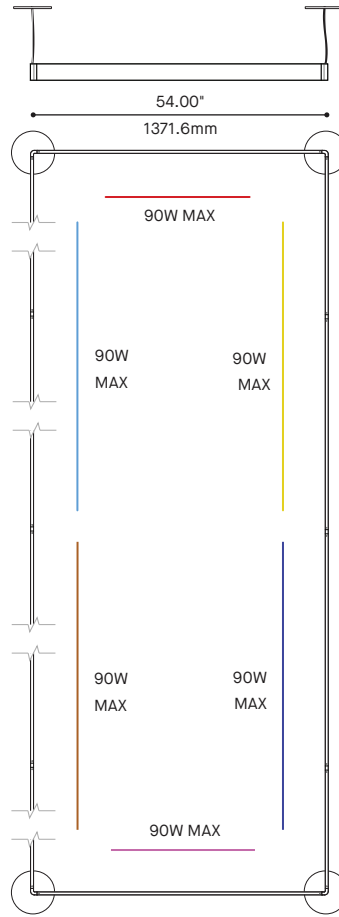

**8220-36X380**  
ARENA RECTANGLE 36" x 380"

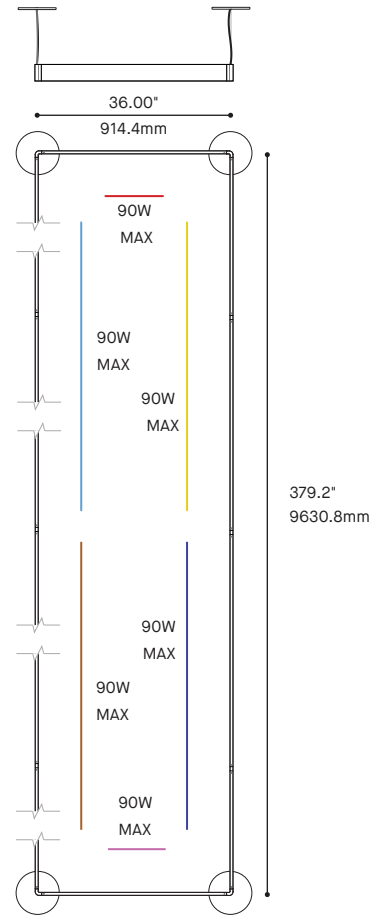

**8220-190X380**  
ARENA RECTANGLE 190" x 380"

